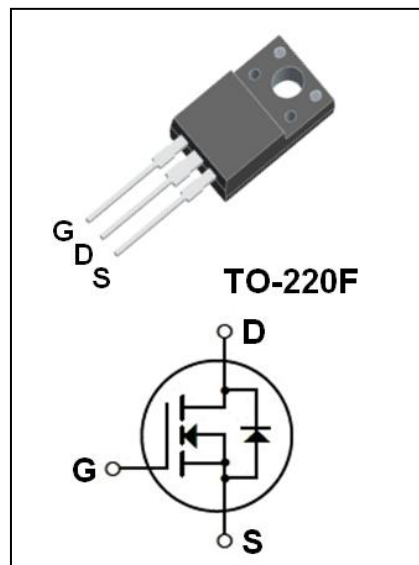

●Features:

- 7.0A, 700V, $R_{DS(on)(Typ)} = 1.2\Omega @ V_{GS}=10V$
- Low Gate Charge
- Low C_{rss}
- 100% Avalanche Tested
- Fast Switching
- Improved dv/dt Capability

●Application:

- High Frequency Switching Mode Power Supply
- Active Power Factor Correction

Absolute Maximum Ratings($T_C=25^\circ\text{C}$ unless otherwise noted)

Symbol	Parameter	Value	Unit
V_{DSS}	Drain-Source Voltage	700	V
I_D	Drain Current - Continuous($T_C=25^\circ\text{C}$) - Continuous($T_C=100^\circ\text{C}$)	7.0*	A
		4.5*	A
I_{DM}	Drain Current -Pulsed (Note1)	28*	A
V_{GSS}	Gate-Source Voltage	± 30	V
E_{AS}	Single Pulsed Avalanche Energy (Note2)	590	mJ
I_{AR}	Avalanche Current (Note1)	7.0	A
E_{AR}	Repetitive Avalanche Energy (Note1)	14.0	mJ
dv/dt	Peak Diode Recovery dv/dt (Note3)	4.5	V/ns
P_D	Power Dissipation($T_C = 25^\circ\text{C}$) -Derate above 25°C	48	W
		0.38	W/ $^\circ\text{C}$
T_j	Operating Junction Temperature	150	$^\circ\text{C}$
T_{stg}	Storage Temperature Range	-55 to+150	$^\circ\text{C}$

* Drain Current Limited by Maximum Junction Temperature.

Thermal Characteristics

Symbol	Parameter	Max	Unit
$R_{\theta JC}$	Thermal Resistance, Junction to Case	2.6	$^\circ\text{C} / \text{W}$
$R_{\theta JA}$	Thermal Resistance, Junction to Ambient	62.5	$^\circ\text{C} / \text{W}$

Electrical Characteristics(Tc=25°C unless otherwise noted)

Symbol	Parameter	Test Conditions	Min	Typ	Max	Unit
Off Characteristics						
BV _{DSS}	Drain-source Breakdown Voltage	V _{GS} =0V, I _D =250μA	700	--	--	V
ΔBV _{DSS} /ΔT _J	Breakdown Voltage Temperature Coefficient	I _D =250μA (Referenced to 25°C)	--	0.7	--	V/°C
I _{DSS}	Zero Gate Voltage Drain Current	V _{DS} =700V, V _{GS} =0V	--	--	1	μA
		V _{DS} =560V, Tc=125°C	--	--	10	μA
I _{GSSF}	Gate-Body Leakage Current, Forward	V _{GS} =+30V, V _{DS} =0V	--	--	100	nA
I _{GSSR}	Gate-Body Leakage Current, Reverse	V _{GS} =-30V, V _{DS} =0V	--	--	-100	nA
On Characteristics						
V _{GS(th)}	Gate Threshold Voltage	V _{DS} = V _{GS} , I _D =250μA	2.0	--	4.0	V
R _{DS(on)}	Static Drain-Source On-Resistance	V _{GS} =10 V, I _D =3.5A	--	1.2	1.4	Ω
g _{FS}	Forward Transconductance	V _{DS} =40 V, I _D =3.5A (Note4)	--	6.5	--	S
Dynamic Characteristics						
C _{iss}	Input Capacitance	V _{DS} =25V, V _{GS} =0V, f=1.0MHz	--	1380	--	pF
C _{oss}	Output Capacitance		--	170	--	pF
C _{rss}	Reverse Transfer Capacitance		--	15	--	pF
Switching Characteristics						
t _{d(on)}	Turn-On Delay Time	V _{DD} = 350 V, I _D = 7.0 A, R _G = 25 Ω (Note4,5)	--	13	--	ns
t _r	Turn-On Rise Time		--	100	--	ns
t _{d(off)}	Turn-Off Delay Time		--	126	--	ns
t _f	Turn-Off Fall Time		--	48	--	ns
Q _g	Total Gate Charge	V _{DS} = 560 V, I _D = 7.0 A, V _{GS} = 10 V (Note4,5)	--	30	--	nC
Q _{gs}	Gate-Source Charge		--	6	--	nC
Q _{gd}	Gate-Drain Charge		--	14	--	nC
Drain-Source Diode Characteristics and Maximum Ratings						
I _S	Maximum Continuous Drain-Source Diode Forward Current		--	--	7.0	A
I _{SM}	Maximum Pulsed Drain-Source Diode Forward Current		--	--	28	A
V _{SD}	Drain-Source Diode Forward Voltage	V _{GS} =0V, I _S =7.0A	--	--	1.4	V
t _{rr}	Reverse Recovery Time	V _{GS} =0V, I _S =7.0A, d I _F /dt=100A/μs (Note4)	--	315	--	ns
Q _{rr}	Reverse Recovery Charge		--	2.6	--	μC

Notes:

- 1、Repetitive Rating:Pulse Width Limited by Maximum Junction Temperature.
- 2、L = 19.5mH, I_{AS} =7.0A, V_{DD} = 50V, R_G = 25 Ω, Starting T_J = 25°C.
- 3、I_{SD}≤7.0A, di/dt≤200A/μs, V_{DD}≤BV_{DSS}, Starting T_J = 25°C.
- 4、Pulse Test : Pulse Width ≤300 μ s, Duty Cycle≤2%.
- 5、Essentially Independent of Operating Temperature.

On-Regin Characteristics

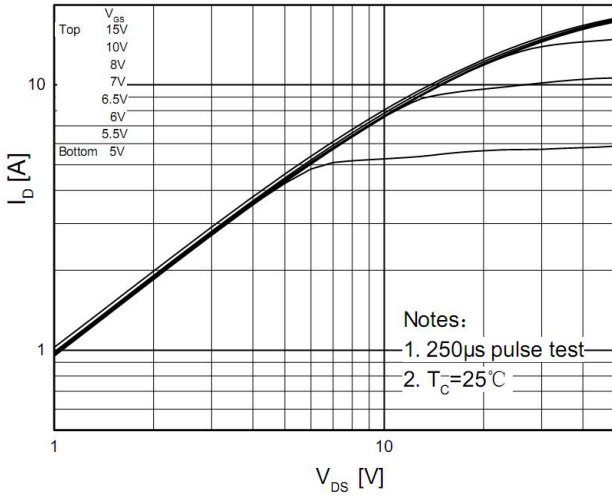

Transfer Characteristics

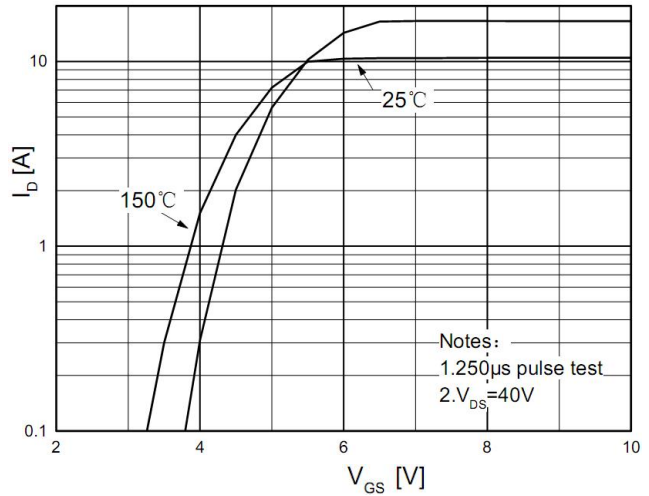

On-Resistance Variation vs. Drain Current and Gate Voltage

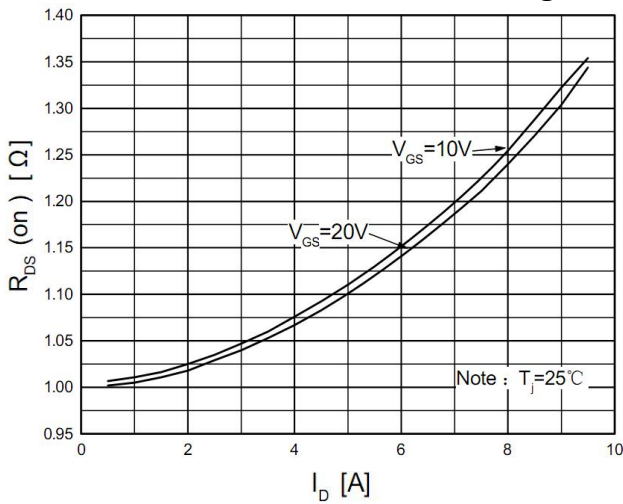

Body Diode Forward Voltage Variation vs. Source Current and Temperature

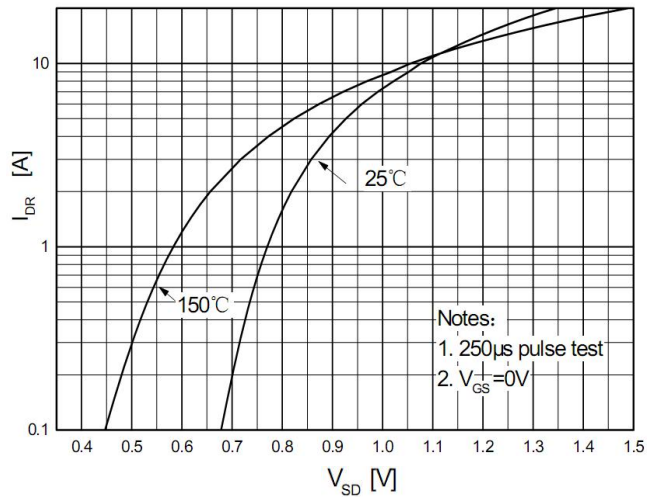

Capacitance Characteristics

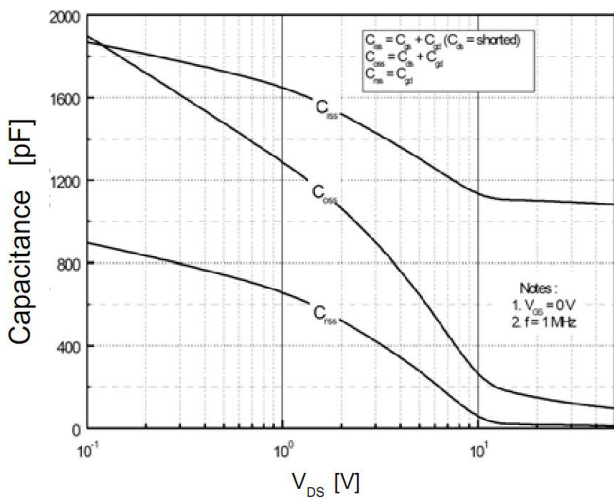

Gate Charge Characteristics

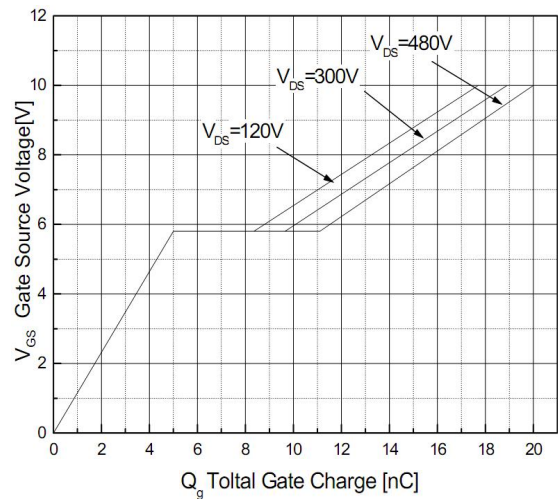

Breakdown Voltage Variation vs. Temperature

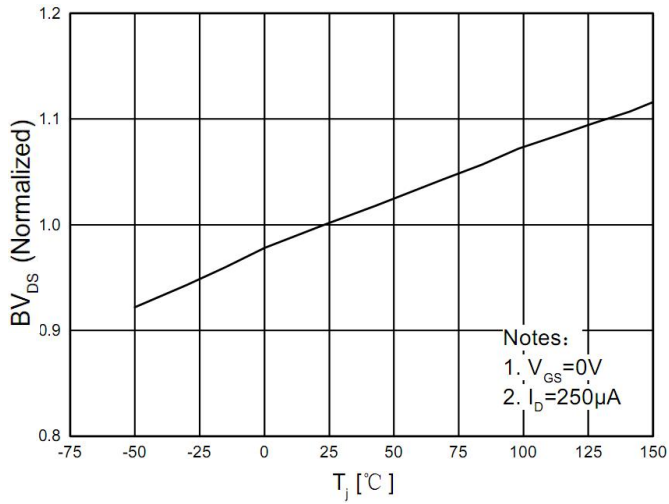

On-Resistance Variation vs. Temperature

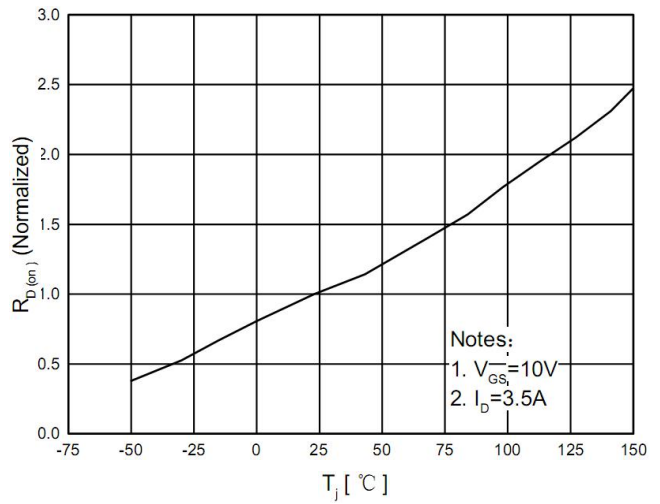

Maximum Safe Operating Area

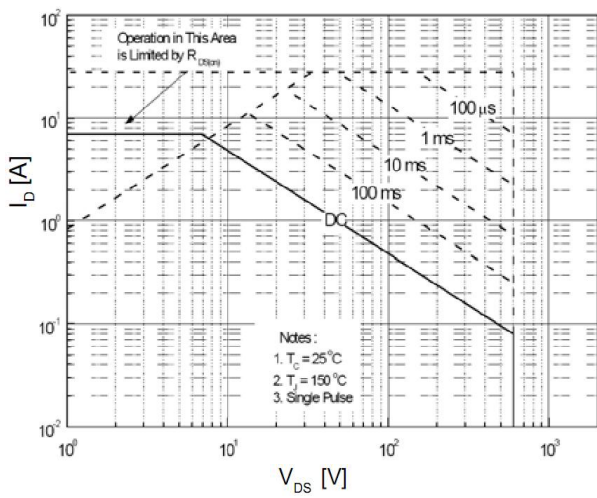

Maximum Drain Current Vs. Case Temperature

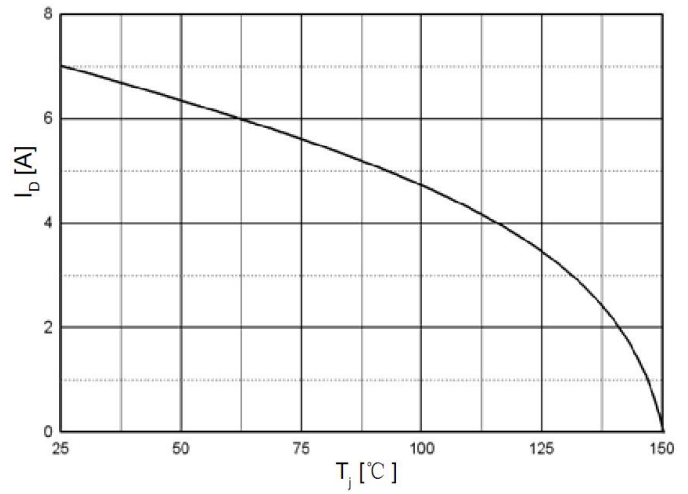

TO-220F Package Dimensions

UNIT: mm

SYMBOL	min	nom	max	SYMBOL	min	nom	max
A	9.80		10.60	D		2.54	
A1		7.00		D1	1.15		1.55
A2	2.90		3.40	D2	0.60		1.00
A3	9.10		9.90	D3	0.20		0.50
B1	15.40		16.40	E	2.24		2.84
B2	4.35		4.95	E1		0.70	
B3	6.00		7.40	E2		1.0×45°	
C	3.00		3.70	E3	0.35		0.65
C1	15.00		17.00	E4	2.30		3.30
C2	8.80		10.80	α (度)		30°	

